



BRITEFOIL™ PRESSURE SENSITIVE LABELS

Thank you for your interest in our pressure sensitive labels. The sample packet included with this information should familiarize you with the type of labels we print. They are made using hot stamp colors like our fabric labels. This means we can print bright metallics or other brilliant colors to enhance your product. We are limited to one and two colors on most label sizes and cannot do an overall color, but we can usually print up to 30% of the surface area of the label on most sizes. It also means we can print a beautiful metallic gold or silver on a black label or print a sharp, clear color on your label.

Also included in this information packet are the various shapes we can make labels. If you need something different, dies can be made at reasonable costs. Our minimum order for BriteFoil labels is 500 labels.

We hope this gives you a place to start designing your label. Please feel free to use any of the type faces or stock artwork included in this brochure. Label materials are listed below as well as the print colors available.

PRICING:

Our pricing is simple. Label materials are classified in **Groups 1, 2 and 3**. Die shapes are classified in **Groups 1, 2, 3 and 4**. Add the group number of the label material and the group number of the die shape—then use the pricing level with the same number as that total. There is a one-time plate/set up charge (see reverse side) for new labels.

LABEL MATERIALS:

Group 1 Materials	Group 2 Materials	Group 3 Materials
<ul style="list-style-type: none"> • White High Gloss • Red Fluorescent • Pink Fluorescent • Brown Kraft 	<ul style="list-style-type: none"> • Pink High Gloss • Dull Silver Foil • Yellow High Gloss • Black High Gloss • Ivory High Gloss 	<ul style="list-style-type: none"> • Chocolate High Gloss • Hunter Green High Gloss • Black Flexible Vinyl • White Flexible Vinyl
		<ul style="list-style-type: none"> • White Pressure Sensitive Satin Rayon

PRINT COLORS:

• Metallic Colors:

Gold, Silver, Bronze, Blue, Teal, Red, Purple, Violet, Green

• Standard Colors:

Black, Grey, Green, Pine Green, Light Blue, Medium Blue, Midnight Blue, Purple, Red, Burgundy, Fuchsia, Brown, White

Please remember that not all colors may be appropriate for, or show up well, on different colored label materials. See chart on the back of this sheet.

PRICES SUBJECT TO CHANGE WITHOUT NOTICE

LABEL PRICES	Level 2		Level 3		Level 4		Level 5		Level 6		Level 7	
	One Color	Two Color	One Color	Two Color	One Color	Two Color	One Color	Two Color	One Color	Two Color	One Color	Two Color
500	\$39.60	n/a	\$49.00	n/a	\$58.00	n/a	\$67.75	n/a	\$79.75	n/a	\$122.70	n/a
1,000	49.50	\$79.20	60.50	\$93.75	72.60	\$102.90	95.70	\$129.70	110.00	\$144.90	185.90	n/a
2,000	42.50	67.75	53.50	80.50	62.50	91.00	82.00	106.50	96.00	126.30	169.80	n/a
3,000	36.50	59.80	47.50	70.30	54.50	81.80	73.50	98.45	87.60	114.60	155.90	n/a
4,000	32.20	51.50	43.20	61.40	46.80	69.30	65.78	87.70	80.50	105.10	145.00	n/a
5,000	28.30	44.70	39.30	54.60	41.00	60.00	59.20	78.54	75.40	98.60	135.30	n/a
7,500	24.75	40.50	35.75	47.00	37.00	54.40	53.60	70.60	70.75	91.90	127.00	n/a
10,000	22.30	35.60	33.30	42.50	35.20	49.00	50.00	64.80	66.10	85.20	120.40	n/a

All Prices Are Per Thousand Labels PLATE/SETUP COSTS: See Other Side

Labels Printed On This Page Are Shown For Graphic Purposes Only And May Not Be Printed To Scale Or Actual Colors

2435 SE Eleventh Avenue • Portland, Oregon 97214
 Ph (503) 234-1054 Fax (503) 234-1294
 email: pslabels@nwtg.com

NOTICE:
 The fabric in this product meets all requirements of Flammable Fabrics Acts. Precaution should be taken to avoid ignition of the nested cotton surface by open flame or other sources of heat.

rev 02/06

Use the chart below to determine which print colors will work for each label material.

		PRINT COLORS																					
		BLACK	GREY	PINE GREEN	LIGHT GREEN	MEDIUM BLUE	MIDNIGHT BLUE	PURPLE	BURGUNDY	RED	FUCHSIA	BROWN	METALLIC GOLD	METALLIC SILVER	METALLIC BRONZE	METALLIC BLUE	METALLIC TEAL	METALLIC PURPLE	METALLIC VIOLET	METALLIC GREEN	WHITE		
LABEL MATERIALS	White Gloss	●	●	●	●	●	●	●	●	●	●	●	●	●	●	●	●	●	●	●	●	●	
	Red Fluorescent	●												●	●	●						●	
	Pink Fluorescent	●												●	●	●	●					●	
	Brown Kraft	●		●			●	●		●	●	●	●	●	●	●						●	●
	White PS Rayon	●	●	●	●		●	●	●	●	●	●	●	●		●	●						
	Dull Silver Foil	●												●	●								
	Yellow Gloss	●	●	●	●		●	●	●	●	●	●	●		●					●			
	Black Gloss													●	●	●				●			
	Chocolate Gloss													●	●	●						●	●
	Ivory Gloss	●	●	●	●	●	●	●	●	●	●	●	●	●	●	●	●	●	●	●	●	●	●
	Hunter Green Gloss													●	●	●			●			●	
	Pink Gloss	●	●	●	●	●	●	●	●	●	●	●	●	●	●	●	●	●	●	●	●	●	●
	Black Vinyl		●							●				●	●	●	●	●	●	●	●	●	●
	White Vinyl	●	●	●	●	●	●	●	●	●	●	●	●	●	●	●	●	●	●	●	●	●	●

Plate/Setup Charges

REV 02/06

Option 1 Up to five (5) STRAIGHT lines of OUR type with OUR borders or lines we create. No graphics or typographical effects. (see order form & tpestyle listing)

- One Color Plate/Setup \$15.00
- Two Color Plate/Setup \$30.00

Option 2 Label setup using either your submitted artwork in combination with our tpestyles or graphics and created borders, if desired — or your completely camera ready artwork.

- One Color Plate/Setup \$40.00
- Two Color Plate/Setup \$62.50

This label would be an Option 1 Setup

2 Point Border We Created
With Five Lines Of Straight Text Only
Outside Edge Of Label



This label would be an Option 2 Setup due to the stylized type and motif



5 Point Border Prints Off Edge Of The Label

Stock Motif Artwork With Our Tpestyles And A Typographical Effect



GROUP 1 DIE SHAPES

$\frac{1}{4}$ " x $\frac{3}{4}$ " #1-003. ▲	$\frac{1}{4}$ " x 1" #1-005. ▲	$\frac{1}{4}$ " x $1\frac{1}{4}$ " #1-007. ▲				
$\frac{3}{8}$ " x $\frac{3}{4}$ " #1-023. ▲	$\frac{3}{8}$ " x 1" #1-024 ▲	$\frac{3}{8}$ " x $1\frac{1}{4}$ " #1-025	$\frac{1}{2}$ " x $\frac{1}{2}$ " #1-040 ▲	$\frac{1}{2}$ " x $\frac{3}{4}$ " #1-041 ▲	$\frac{1}{2}$ " X 1" #1-042. ▲	$\frac{1}{2}$ " x $1\frac{1}{4}$ " #1-043 ▲
$\frac{3}{4}$ " x 1" #1-061 ▲	$\frac{5}{8}$ " x 1" #1-062. ▲	$\frac{5}{8}$ " x $1\frac{1}{4}$ " #1-063. ▲	$\frac{5}{8}$ " x $1\frac{1}{2}$ " #1-064. ▲	$\frac{1}{2}$ " x $1\frac{1}{2}$ " #1-044 ▲	$\frac{1}{2}$ " x 1" #1-640. ▲	
$\frac{3}{4}$ " x $\frac{3}{4}$ " #1-080 ▲	$\frac{3}{4}$ " X 1" #1-081 ▲	$\frac{3}{4}$ " x $1\frac{1}{4}$ " #1-082. ▲	$\frac{3}{4}$ " x $1\frac{1}{2}$ " #1-083 ▲	$\frac{3}{4}$ " x $1\frac{1}{2}$ " #1-642. ▲		
1" x 1" #1-120. ▲	$\frac{1}{2}$ " #1-551 ▲	$\frac{3}{4}$ " #1-553. ▲	1" #1-555. ▲	Rounded Top Rectangle $1\frac{3}{16}$ " x $1\frac{1}{4}$ " #1-440. ▲	$\frac{5}{8}$ " X $1\frac{1}{4}$ " #1-641. ▲	$\frac{7}{8}$ " x $1\frac{1}{4}$ " #1-601. ▲

GROUP 2 DIE SHAPES

rev02/06 ▲ Direction of feed off roll

$\frac{5}{8}$ " x 2" #2-066. ▲	$\frac{3}{4}$ " x $1\frac{3}{4}$ " #2-084. ▲	$\frac{3}{4}$ " x $2\frac{1}{2}$ " #2-087. ▲	
1" x $1\frac{1}{4}$ " #2-121 ▲	1" x $1\frac{1}{2}$ " #2-122. ▲	1" x $2\frac{1}{2}$ " #2-126. ▲	$1\frac{1}{4}$ " x $1\frac{1}{2}$ " #2-161. ▲
1" x 3" #2-128. ▲	$1\frac{1}{4}$ " X $1\frac{3}{4}$ " #2-162 ▲	$1\frac{1}{4}$ " X 2" #2-163. ▲	
$1\frac{1}{2}$ " x $1\frac{3}{4}$ " #2-201. ▲	$1\frac{1}{2}$ " X 2" #2-202. ▲	$1\frac{1}{4}$ " x $2\frac{1}{4}$ " #2-164. ▲	

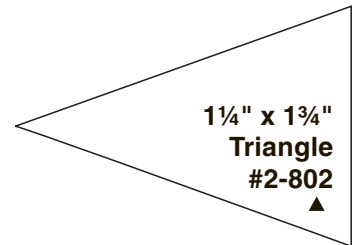
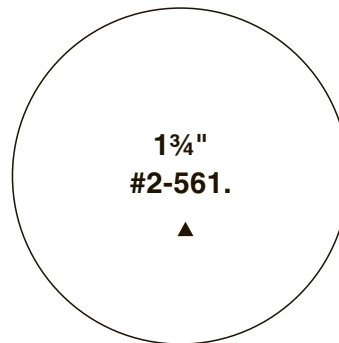
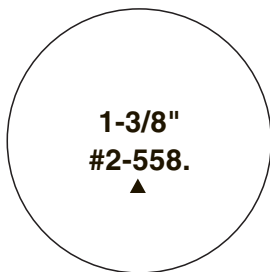
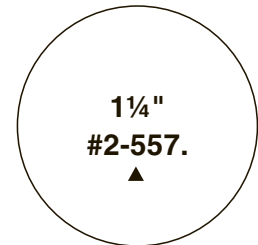
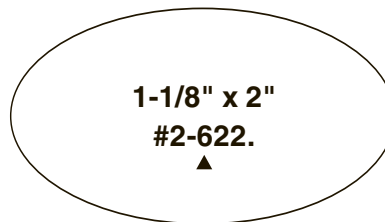
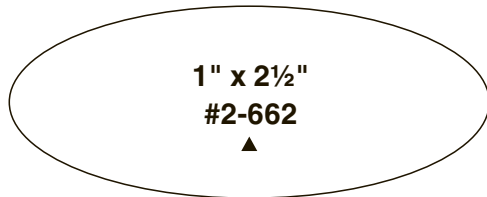
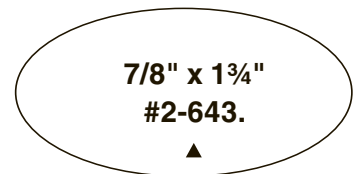
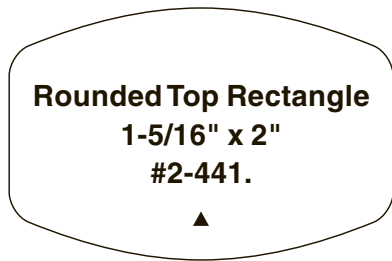
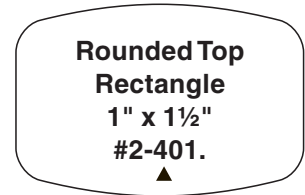
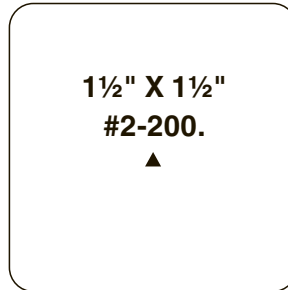
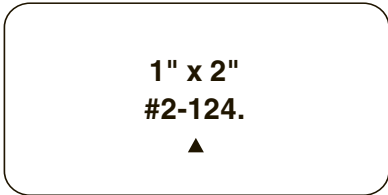
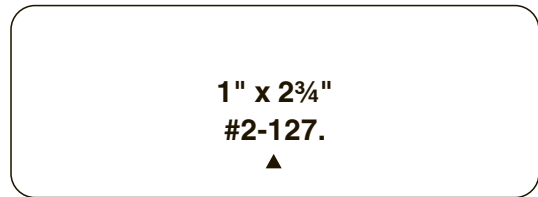
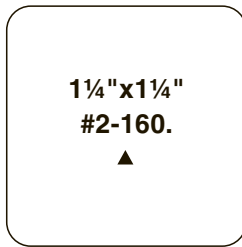
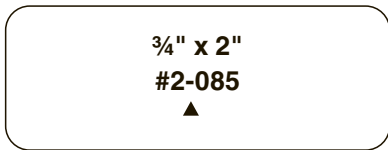

GROUP 3 DIE SHAPES

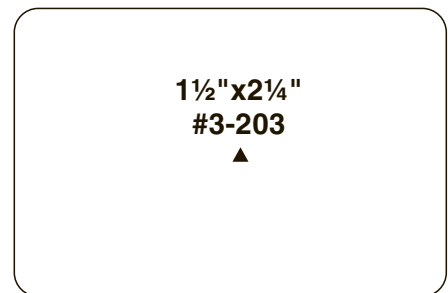
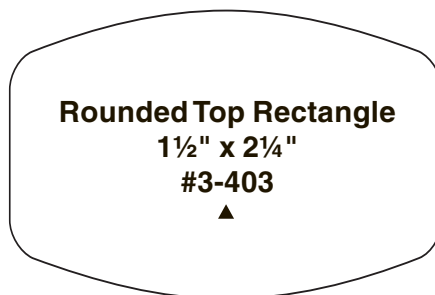
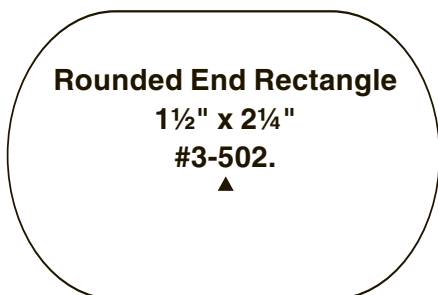

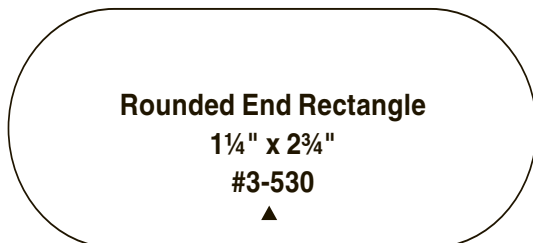
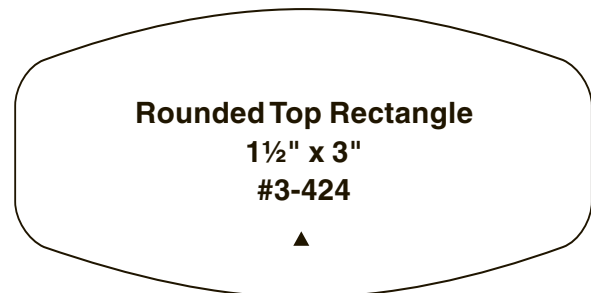
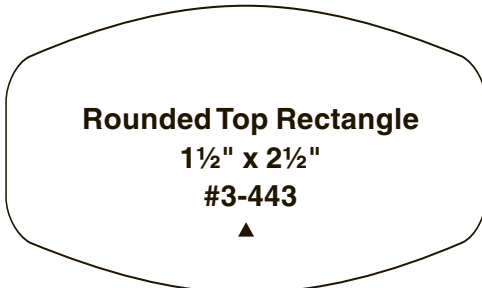
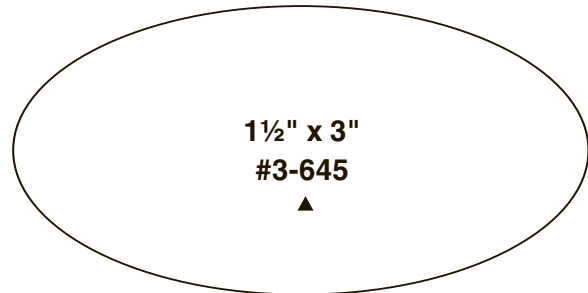
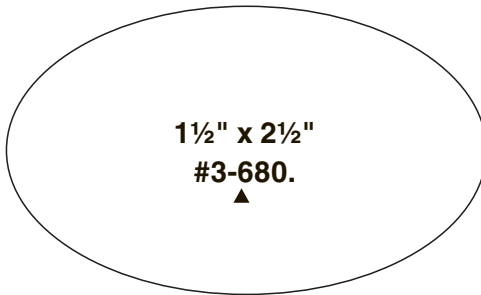
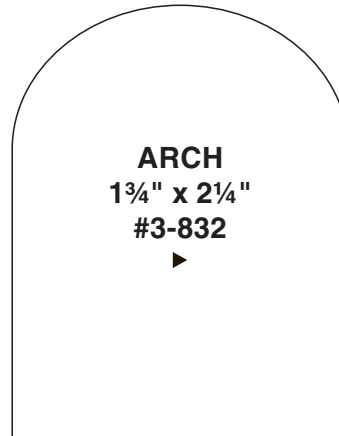
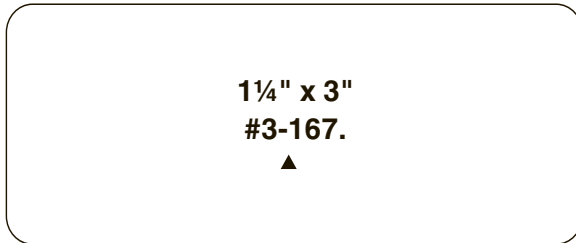
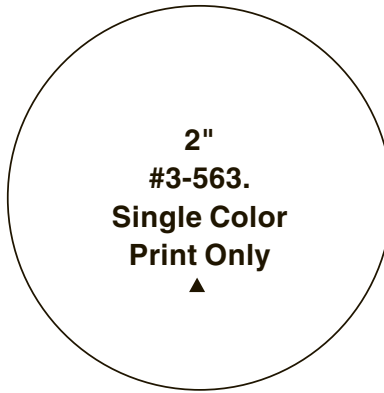
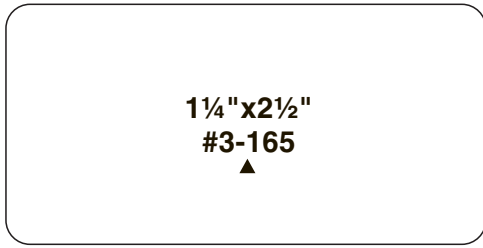

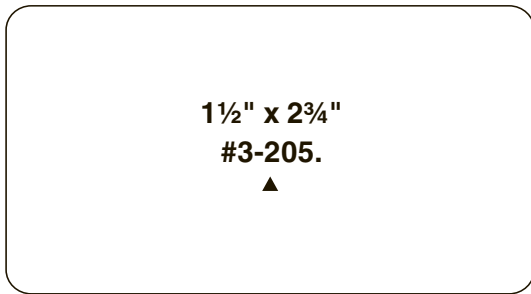

1-7/8" x 2"
#3-826
Single Color
Print Only
▶

GROUP 4 DIE SHAPES

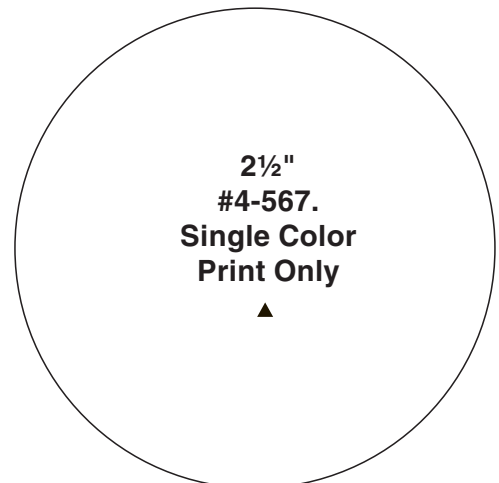
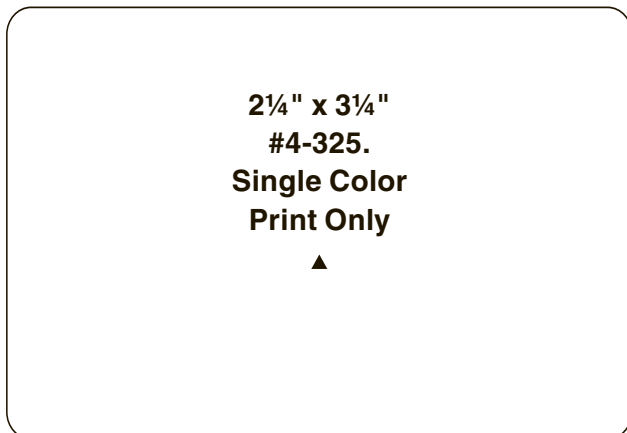
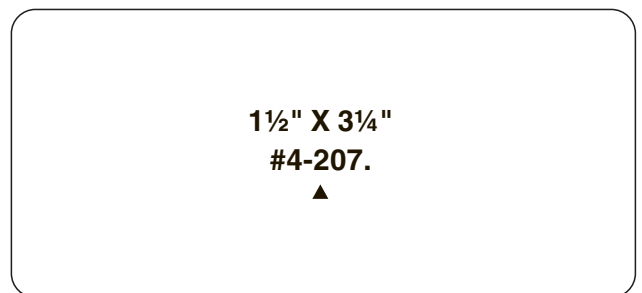
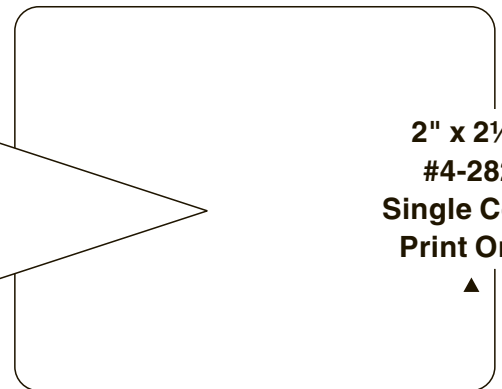
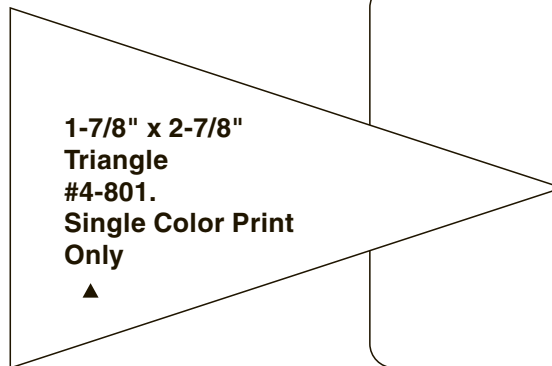

COST OF LABELS

CUSTOM PRESSURE SENSITIVE LABELS

Quantity Of Labels Ordered.....	\$	
Plate / Setup Charge.....	\$	
Proof Charge (if you are ordering less than 1,000 labels)..\$3 ⁰⁰	\$	
SUBTOTAL	\$	
Shipping/Handling/Insurance (from chart below).....	\$	
TOTAL COST		\$

SHIPPING, INSURANCE & HANDLING

ORDER COST	UPS SURFACE	3 DAY SELECT	2nd DAY AIR
.01 - \$ 99.99	\$ 7.80	\$12.70	\$19.00
\$100.00 - \$149.99	\$ 9.95	\$14.95	\$25.00
\$150.00 - \$199.99	\$11.35	\$16.90	\$29.50
\$200.00 - up	\$12.80	call or email your ZIP CODE	call or email your ZIP CODE

REV 02/06

Check Enclosed (Please Call To Verify Total)



Bill My MC, Visa, Amex, Discover Card
(Account is charged when order is entered. Charge slip sent with shipment.)

_____ card number

_____ expiration date

_____ Address and Zip Code that this credit card's bill is delivered to.

- **Alaska, Hawaii, Canada** and other international locations, please call or email with your **ZIP Code (Postal Code)** and **Total Order Amount** for shipping costs.
 - Import duties, if any, are customer responsibility.
- ALL PRICES SUBJECT TO CHANGE WITHOUT NOTICE

Terms & Conditions of Sale

By completing this form and submitting an order to Northwest Tag & Label, Inc. (NWTL) customer agrees to the following terms and conditions of sale:
Northwest Tag & Label reserves the right to decline any order for any reason. Defective labels will be replaced as quickly as possible in a businesslike manner upon demonstration to NWTL of such a condition. Reshipment of replacement labels will be made by UPS 2nd Day Air. (U.S. only) While every effort is made to remain within delivery

guidelines, NWTL assumes NO responsibility for specific ship dates. An expected ship date is a projection and may vary due to circumstances beyond our control. NWTL accepts no financial liability for delivery beyond published projections. Limits of product liability extend solely to the replacement of defective or incorrect labels and cannot exceed that cost. Customer agrees to repackage defective or incorrect labels for pickup by UPS, as directed by NWTL.

Why don't we mail packages? Dropping your label order in the mail sends it out with no method of tracking the package. If it doesn't arrive at your place of business, and you call to check on delivery, we have no way of finding out where the package is or when it may be delivered.....if ever. Together, we then have the difficulty of sorting out who is responsible for a package that hasn't arrived and may, or may not be lost.

Northwest Tag & Label ships several hundred packages daily. The only workable shipping method is one that picks up at our printing facility, allows constant tracking of a package from our business to yours, and provides insurance against loss; as well as a definitive method of determining **when** a package is lost so a replacement shipment can be made. UPS is the cost effective way to ship small packages that meets the above criteria. Packages are electronically scanned at Northwest Tag & Label, then scanned at each stop throughout the delivery path to you. That information is readily available via our Internet connection so we can tell you exactly where your package is, and approximately when it will be delivered.

With the tracking number and an Internet connection, you can even track the package yourself. Just ask us to email the UPS tracking number when the package ships.